

Accuphase

MMB COMPACT DISC PLAYER

DP-65V

- Totally separate CD transport and processor sections
- MMB type D/A converter assures amazing conversion precision
- Two sets of digital inputs and outputs
- Jitter-free high-performance digital demodulator
- Option board slots allow adding digital inputs and outputs
- Fully digital control of CD mechanism
- Balanced actuator drive circuitry



COMPACT
disc
DIGITAL AUDIO

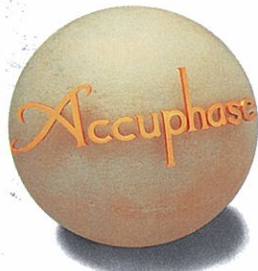

Integrated CD player features totally separate CD transport and processor section. MMB type D/A converter assures amazing conversion precision. Fully digital control of CD mechanism allows real-time optimization of servo parameters. Two sets of coaxial and optical digital inputs and outputs plus option board slots provide total flexibility.

The DP-65V may look like a conventional Compact Disc player from the outside, but it really consists of an entirely separate transport section and digital processor combined in one unit. This product fully reflects Accuphase's extensive experience with high-class separate components for CD reproduction.

The D/A converter in the processor section features the high-precision MMB principle developed by Accuphase. Four D/A converters selected according to strict sound quality criteria are connected in parallel, resulting in dramatically improved linearity, THD, dynamic range, and signal-to-noise ratio. Digital inputs allow use of this ultimate D/A conversion system also with external components. Since a digital output carrying the signal from the CD transport is also provided, the Digital Voicing Equalizer DG-28 can be easily inserted into the signal path.

The CD transport side of the DP-65V is impressive as well. For example, it uses fully digital circuits for mechanism control. This allows optimizing servo performance for each individual disc, assuring improved operation stability and a drastic reduction in error rate. The laser pickup is an ultra-compact type with integrated RF amplifier, and all actuators are driven by balanced circuits which do not conduct any current to the ground line. The tray lock feature firmly secures the tray during playback, eliminating mechanical resonances, which maintains the high purity of the digital signal.

The digital output makes it easy to directly supply the digital signal from the CD transport to the Digital Preamplifier DC-300. Other possible applications include connection of a digital recorder such as a DAT or MD unit, for direct recording of the signal in the digital domain. Option board slots on the rear panel (compatible with the range of boards available for the DC-300 and DG-28) allow increasing the number of inputs and outputs, to accommodate a variety of components.

The digital output makes it easy to directly supply the digital signal from the CD transport to the Digital Preamplifier DC-300. Other possible applications include connection of a digital recorder such as a DAT or MD unit, for direct recording of the signal in the digital domain. Option board slots on the rear panel (compatible with the range of boards available for the DC-300 and DG-28) allow increasing the number of inputs and outputs, to accommodate a variety of components.

[Digital Processor Section]

MMB Type D/A Converter Achieves 20-Bit Linearity and Ultra Low Noise

The D/A converter uses the amazing MMB (Multiple Multi-Bit) principle which delivers performance and sound quality previously thought unattainable. It consists of four strictly selected 20-bit D/A converters connected in parallel. This revolutionary approach yields a dramatic improvement in every important performance aspect.

As can be seen from the illustration, the high-speed output of an 8-times oversampling digital filter is connected in parallel to the individual converters. Immediately after D/A conversion, the output of the converters is combined while still in high-speed form. But rather than simply linking the

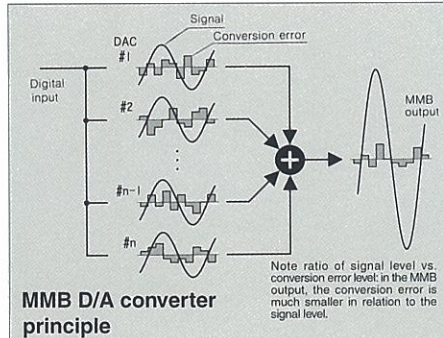

converter elements in parallel, the MMB circuit drives each converter separately, so that it can develop its full potential. Special attention was devoted to phase response at high frequencies. Parts selection, layout and wiring patterns were optimized to achieve perfect phase matching. The end result is performance which sets new standards regarding linearity and absence of distortion and noise.

An important characteristic of the MMB principle is the fact that it improves performance regardless of signal level and frequency. The converter

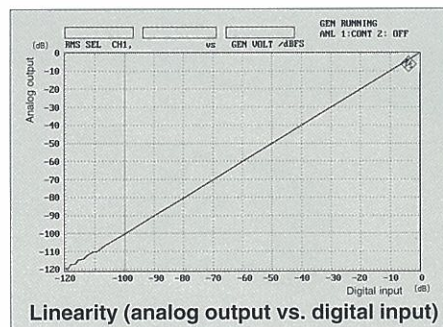

therefore maintains excellent linearity even at extremely low levels that present insurmountable problems for conventional converter designs. The audible advantages are immediately apparent as more precise localization of sound sources and a heightened sense of space and ambience. As illustrated by the performance chart, linearity of digital input vs analog output is maintained from the highest signal level down to minute levels as low as -110 dB (the theoretical limit of 16-bit CD sources is -96 dB).

Totally Separate Processor Section With Coaxial and Optical Input for Digital Signals

A digital input allows the user to enjoy the top-level performance of the processor section also with other components that can supply a digital signal, such as another CD transport unit, DAT recorder, MiniDisc



Digital input connectors

recorder etc. For utmost flexibility, the input can handle both optical and coaxial connections. Internal processing of audio data is designed to manage all data from these inputs in 24-bit format.

Jitter-Free High-Performance Digital Demodulator

Demodulation of the digital signal is carried out by a CS8412 chip (made by Crystal Semiconductor). This device not only has extremely low inherent jitter, it also is capable of absorbing any jitter components present in the input signal. Since the chip can handle digital signals up to a width of 24 bits, the advantages of the MMB principle are realized with any type of program source.



20-Bit, 8-Times Oversampling Digital Filter

The purpose of a digital filter is to multiply the sampling frequency by an integer, thereby moving any spurious noise components far outside the audible range.

The filter in the DP-65V is manufactured by NPC and offers state-of-the-art characteristics in all vital aspects, such as absence of group delay, passband ripple, and attenuation.

The filter approaches the theoretical limits of performance. The deemphasis stage features an IIR (Infinite Impulse Response) design to assure precise gain and phase characteristics.



4-Pole Analog Filter With Hand-Selected Components

To reduce noise in the upper frequency range and achieve high S/N ratio, a 4-pole Butterworth design is used for analog filtering. The cutoff frequency point is optimized to keep phase shifts in the passband range at an absolute minimum. Strict selection of all filter components assures sonic purity and total musical accuracy.

Digital Level Control Prevents Sound Quality Deterioration

The 20-bit MMB D/A converter in the DP-65V has a 4-bit margin, which allows precise level attenuation down to -40 dB without any loss in signal quality.

Provisions for Direct Connection of Digital Voicing Equalizer DG-28

Because the CD transport section and digital processor section in the DP-65V are entirely separate, the DIGITAL Voicing Equalizer DG-28 can be inserted into the signal path, to allow sound field control of the signal entirely in the digital domain.

Fully Balanced Analog Output Circuitry

The audio output section features completely balanced circuitry which is isolated from the ground line. Any noise that may be induced in the signal path will be canceled out, so that the playback sound remains utterly pure and undiluted.



[CD Transport Section]

Fully Digital Control of CD Mechanism

The control circuitry of the mechanism section is fully digital, allowing the use of adaptive filters to optimize servo performance for each individual disc. This assures enhanced operation stability and a drastic reduction in error rate. Long-term reliability and performance uniformity are also improved, since fluctuations in ambient temperature can have no adverse influence.

Laser Pickup With Integrated RF Amplifier for Error-Free Operation

Since the output level of a laser pickup is very low, it is highly vulnerable to externally induced noise. To prevent such problems, the pickup used in the DP-65V employs an RF amplifier which is so compact that it can be directly integrated in the pickup assembly. This assures that the high-level output signal remains free from noise interference, which in turn reduces the error rate.

Balanced Drive Circuitry for Servo Motors

The motors and actuators which drive the disc tray, spindle, sled, and the focussing and tracking assembly require a rapidly fluctuating drive current, which can affect other circuit areas and

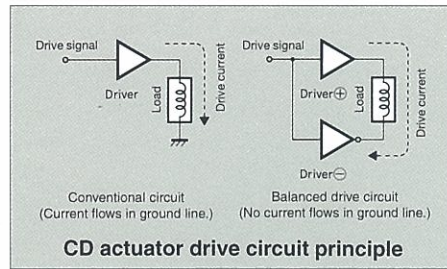

cause sound quality degradation. In the DP-65V, the drive current for each actuator is provided by two amplifiers arranged in a balanced configuration. Because there is no circuit flowing in the ground line, the operation of other circuits in the player remains entirely unaffected.

Power-On Play and Frame Display

"Power-on play" means that the DP-65V can start playback when power is turned on, allowing automatic playback when used together with an audio timer. For precise location of any spot on a disc, the player can display frame information (1 frame = 1/75 second), and functions such as search and repeat can be carried out in steps of individual frames.

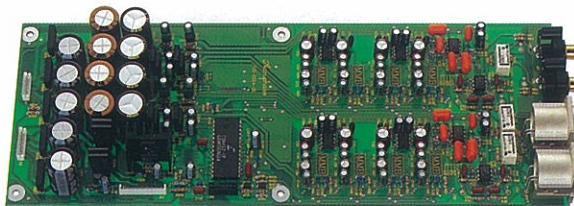

D/A converter and analog circuit assembly

This assembly comprises the MMB type D/A converter, 4-pole analog filter, power supply circuit, balanced/unbalanced output circuit, output connectors and other components.

Digital circuit assembly

This assembly comprises the digital servo control IC, balanced actuator drive circuit and other components.

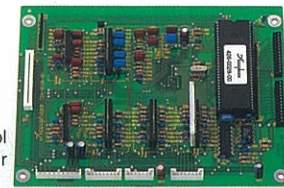

Remote commander RC-18

Allows operation of all functions except power on/off. Enjoy superb convenience by switching input sources or controlling features such as direct play, program play and repeat play.

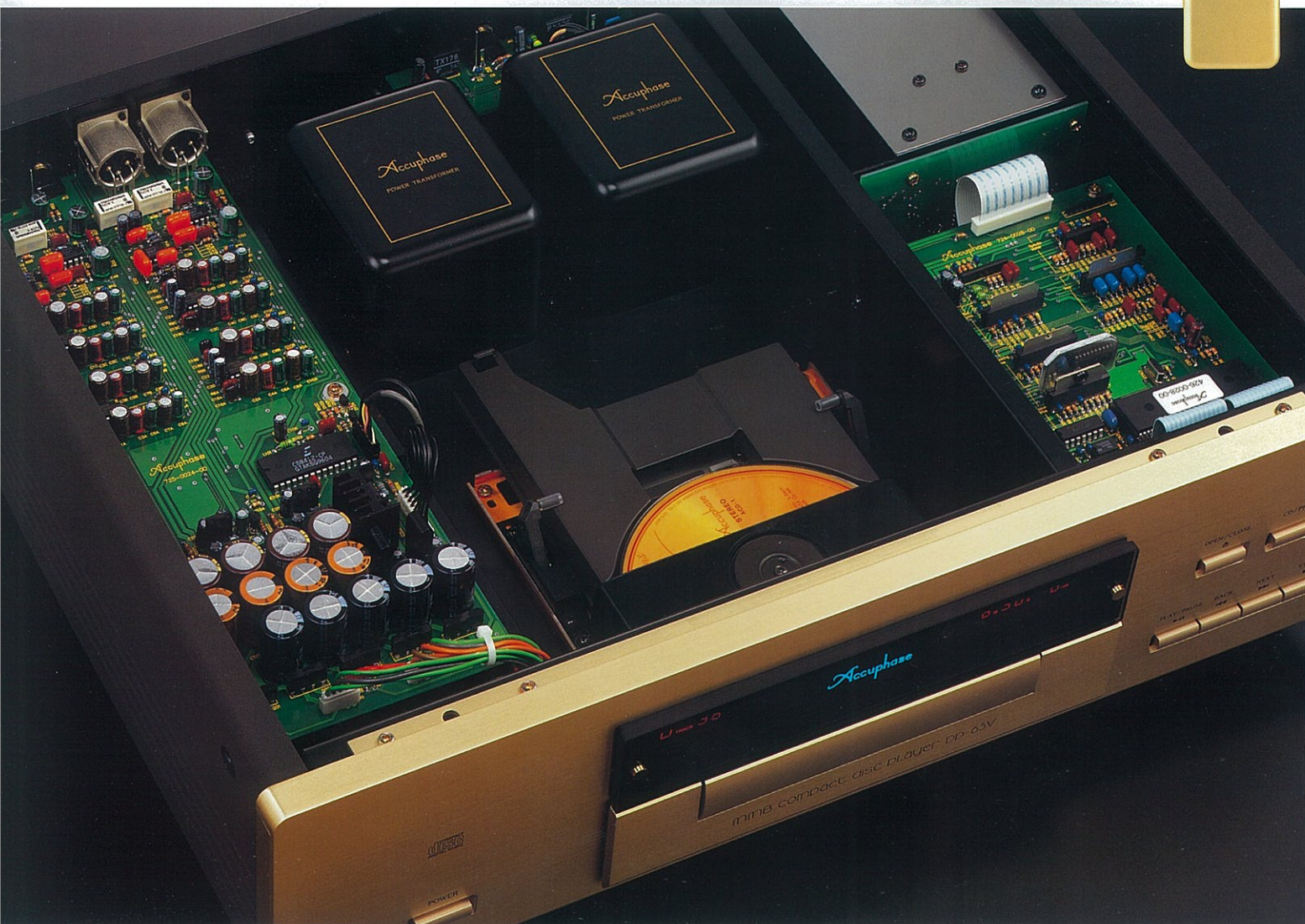

Tray Lock Prevents Resonances

If the disc tray is disengaged from the rotating assembly while the disc is playing, resonances can degrade the signal quality. In the DP-65V, the tray is firmly secured during playback, to eliminate any possibility of harmful resonances.

Two Digital Outputs Allow Recording of Signal in Digital Domain

An optical and coaxial digital output both carry the signal from the CD transport, which allows for example direct connection to the Digital Preamplifier DC-300 or feeding the signal to a digital recorder. Operation of the CD transport continues also when the unit is switched to digital processor operation, allowing recording to be carried out without interruption.

Option Boards

The DP-65V has two dedicated slots which accept a variety of option boards (same as for DC-300 and DG-28). This allows the user to easily increase the number of inputs and outputs, simply by installing a desired board in a rear panel slot.

- ✳ Digital input board operates as additional input for processor section.
- ✳ Digital output board operates as additional output for CD transport section.

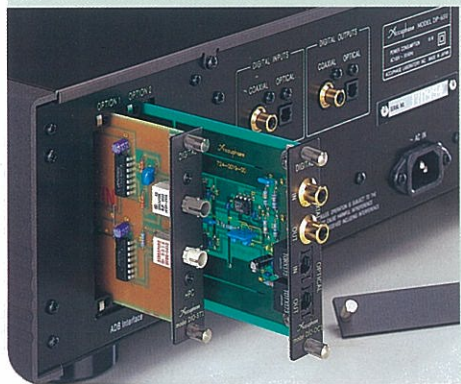

HPC Coaxial Input Board DI-BNC1
Uses a coaxial cable (75 ohms) with BNC connector.

HPC Optical Input Board DI-ST1
Serves for connection of an HPC optical fiber link corresponding to the ST standard.

Digital Input/Output Board DIO-OC1
Provides two sets of coaxial and optical connectors, for input and output of digital signals.

HPC Optical Input/Output Board DIO-ST1
Allows connection via an ST type optical link.

AES/EBU Input/Output Board DIO-PRO1
Provides a set of XLR input and output connectors conforming to AES/EBU professional digital standards.

* All boards use the Accuphase Digital Bus (ADB) Interface.

FRONT PANEL

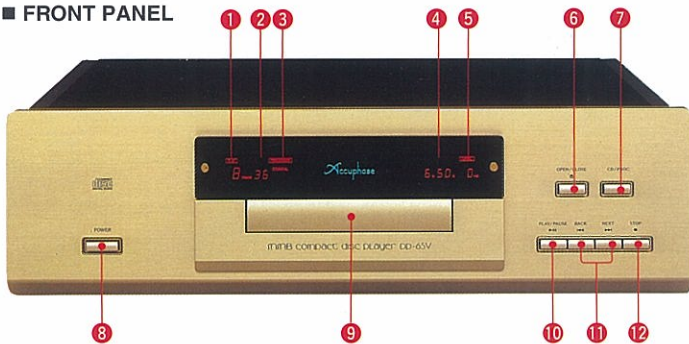

REAR PANEL

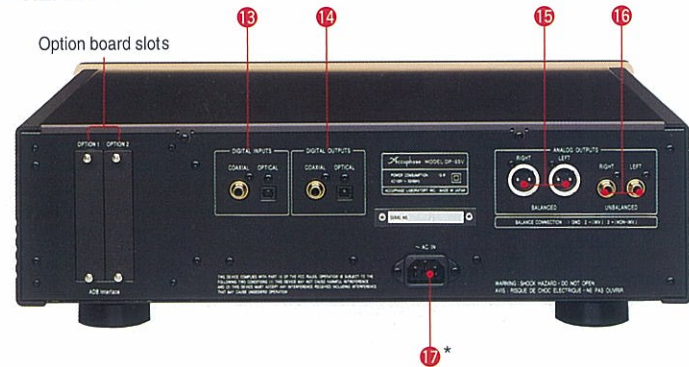

- 1 Play track indicator
- 2 Track/index indicator
- 3 Digital input indicator (processor in use)
- 4 Time indicator
- 5 Output level indicator
- 6 Disc tray open/close button
- 7 CD transport/processor input selector
- 8 Power switch
- 9 Disc tray
- 10 Play/pause button

- 11 Track search button
- 12 Stop button
- 13 Digital inputs (coaxial, optical)
- 14 Digital outputs (coaxial, optical)
- 15 Balanced output connectors (analog output)
 - ① Ground ② Inverted (-)
 - ③ Non-inverted (+)
- 16 Unbalanced output jacks (analog output)
- 17 AC input connector *

Remarks

* The shape of the plug of the supplied power cord depend on the voltage rating and destination country.

- Supplied accessories
 - AC power cord
 - Audio cable with plugs
 - Remote commander RC-18

* Specifications and design subject to change without notice for improvements.

DP-65V GUARANTEED SPECIFICATIONS

[Guaranteed specifications are measured according to the EIA standard CP-2402.]
[Measurement disc: CP-2403]

[CD transport]

- **Format**
 - Standard CD format
 - Quantization : 16 bit
 - Sampling frequency : 44.1 kHz
 - Error correction principle : CIRC
 - Number of channels : 2
 - Revolution speed : 500 - 200 rpm (constant linear velocity)
 - Scan velocity : 1.2 - 1.4 m/s, constant
 - Non-contact optical pickup (semiconductor laser)
 - GaAlAs (double heterodyne diode)
- **Data read principle**
- **Laser type**

[Digital Processor]

- **Input format**
 - EIA standard
 - Quantization : 16 - 24 bit, linear
 - Sampling frequency : 32 kHz, 44.1 kHz, 48 kHz (automatic detection)
- **Digital input format and level (EIAJ CP-1201)**
 - Format : Digital audio interface
 - OPTICAL : Input -27 to -15 dBm
 - Wavelength 660 nm
- **Digital output format and level (EIAJ CP-1201)**
 - COAXIAL: : 0.5 Vp-p, 75 ohms
 - Format : Digital audio interface
 - OPTICAL : Output -21 to -15 dBm
 - Wavelength 660 nm
 - COAXIAL : 0.5 Vp-p, 75 ohms
- **Frequency response** : 4.0 to 20,000 Hz ±0.3 dB
- **D/A converter** : MMB type, 20 bit
- **Digital filter** : 20-bit, 8-times oversampling
Digital deemphasis; Deviation: ±0.001 dB
- **Total harmonic distortion** : 0.0025% (20 - 20,000 Hz)
- **Signal-to-noise ratio** : 118 dB
- **Dynamic range** : 98 dB
- **Channel separation** : 107 dB
- **Output voltage and impedance**
 - BALANCED : 2.5 V into 50 ohms, balanced XLR type
 - UNBALANCED : 2.5 V into 50 ohms, RCA-type phono jack
- **Output level control** : to -40 dB in 1-dB steps
- **Power requirements** : 100V, 120V, 220V, 230V, 240V (voltage as indicated on rear panel)
AC, 50/60 Hz
- **Power consumption** : 18 W
- **Dimensions** : 475 mm (18-11/16") width,
150 mm (5-7/8") height
392 mm (15-7/16") depth
- **Weight** : 17.7 kg (39 lbs) net
22.7 kg (50 lbs) in shipping carton
- **Supplied Remote Commander RC-18**
 - Remote control principle : infrared pulse
 - Power requirements : 3 V DC (IEC R6 batteries x 2)
 - Dimensions : 55 (width) x 194 (depth) x 18 (height) mm
 - Weight : 100 g (including batteries)

Accuphase
ACCUPHASE LABORATORY INC.

PRINTED IN JAPAN A9810Y 851-0152-00(AD1)